

**Nuova collezione 2024**  
*New collection 2024*





Nel settore dell'arredo dal 1954, la società ha puntato sin dall'inizio sul binomio alta tecnologia e design, grazie alla sua flessibilità produttiva: BK GROUP è infatti una delle poche realtà a curare internamente l'intero ciclo di produzione del divano letto: dalla carpenteria, per la lavorazione delle parti metalliche necessarie alla realizzazione dei meccanismi, al reparto tappezzeria e a quello dedicato all'assemblaggio dei semilavorati. Nei laboratori di BK GROUP, inoltre, vengono realizzati anche tutti i prototipi progettati dagli architetti. Qualità, puntualità nelle consegne, forte attenzione all'etica (certificazioni di compatibilità ambientale) e posizione finanziaria solida sono poi le caratteristiche che hanno reso BK GROUP un punto di riferimento nel settore, sia sul mercato italiano che internazionale, in ambito privato e professionale.

*Operating in the furniture sector since 1954, the company has bet on the combination of technology and design since the very beginning, thanks to its production flexibility. BK GROUP is, in fact, one of the few companies to manage the entire sofa bed production cycle: from the carpentry department, where the metal parts needed for the mechanisms are made, to the upholstery department, to the department where semi-finished items are assembled together. In addition, all the prototypes designed by architects are made in the BK GROUP laboratories. Quality, timely deliveries, strong focus on ethics (environmental compatibility certificates) and a solid financial position are the characteristics that have made BK GROUP a point of reference in the sector, on both the Italian and international market, in the private and professional sector.*

## Azienda Company







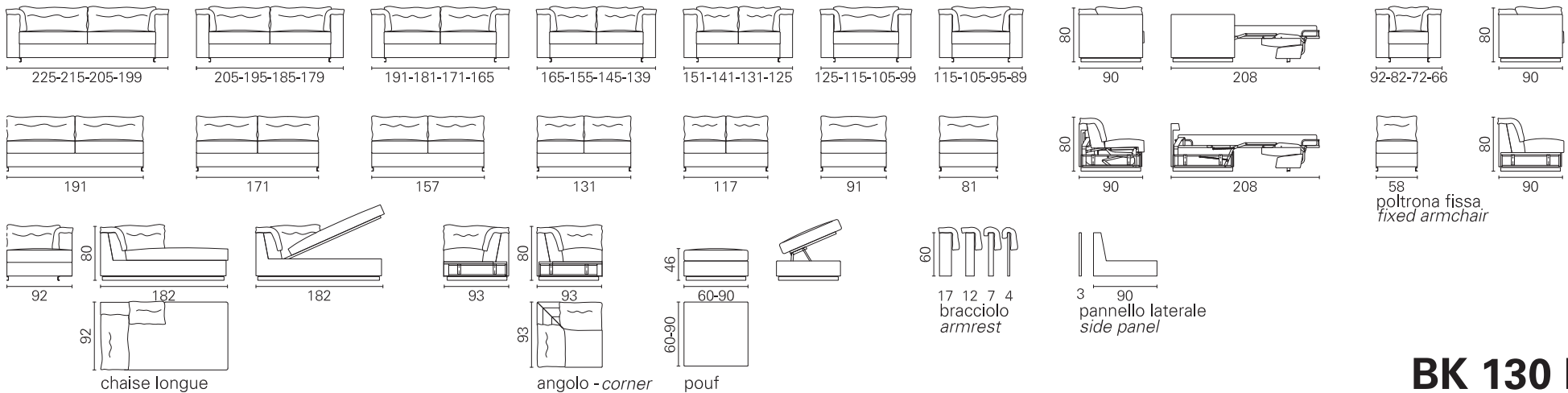

## BK 130 DOBP

### Allestimento standard: (dettagli alla fine del catalogo)

- meccanismo Cube - rete a doghe
- materasso a molle Bonnel
- scelta braccioli cm. 17 - 12 - 7 - 4
- cuscini di seduta composta: parte inferiore in poliuretano alta densità, parte superiore in morbida fibra insacchettata
- cuscini schienale e braccioli in morbida fibra
- schienale con imbottitura in poliuretano completa, per un maggiore confort
- sistema di montaggio a baionetta, sfoderabilità completa, rivestimento in tessuto coordinabile, eco-pelle e pelle

### Standard equipment: (details at the end of catalogue)

- mechanism Cube - orthopaedic bedstead with slats
- spring Bonnel mattress
- armrests choice cm. 17 - 12 - 7 - 4
- composed seat cushions: underlying part in high density polyurethane, upper part in soft pocketed fibre
- backrest and armrest cushions in soft fibre
- backrest with full polyurethane padding, for added comfort
- bayonet mount system, completely removable covers, in coordinabile fabric, similar leather and leather

### Opzioni: (dettagli alla fine del catalogo)

- materassi: molle insacchettate indipendenti, molle insacchettate con lastra in memory, poliuretano ad elevato confort, poliuretano con lastra in memory, poliuretano indeformabile h.18 ad elevato confort
  - coprimaterasso bianco con elastico, lavabile
  - pouf in tessuto coordinabile
  - componibilità completa, sia lineare che angolare, con letto o senza
  - Chaise longue con o senza contenitore, divani e poltrone anche senza letto
- Options: (details at the end of catalogue)**
- mattress: independent pocket spring mattress, independent pocket spring mattress with memory, poliurethane foam mattress - high confort, memory foam mattress, polyurethane foam mattress h.18 - high confort
  - mattress cover white fabric, washable with elastic
  - pouf in coordinabile fabric
  - complete modularity, both linear and angular, with or without bed
  - Chaise longue with or without box, sofas and armchairs even without bed

### BK 130

Materasso  
Mattress

Boss

Misura  
Size

cm 176 x 195  
cm 156 x 195  
cm 142 x 195  
cm 116 x 195  
cm 102 x 195  
cm 77 x 195  
cm 67 x 195

Misura divano  
Sofa size

225  
205  
191  
165  
151  
125  
115

Poltrona fissa  
Fixed armchair

92

**BK** ITALIA

*Convertibles*

**Trasformabile**  
**BK 130 DOBP**

Dante O. Benini e Luca Gonzo



**BK** ITALIA

*Convertibles*

**BK 130 DOBP Varianti / Variants**



Bracciolo 17 / Armrest 17



Bracciolo 12 / Armrest 12



Bracciolo 7 / Armrest 7



Bracciolo 4 / Armrest 4





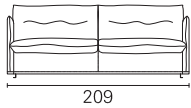

209

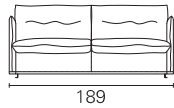

189

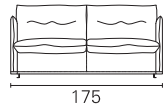

175

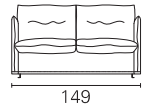

149

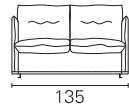

135

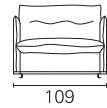

109



99

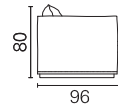

80

96

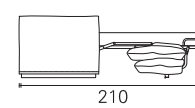

210



76  
poltrona fissa  
fixed armchair

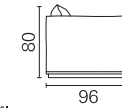

80

96

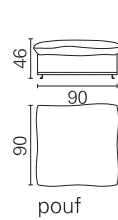

46

90

pouf



46

60

pouf

## BK 131

### Allestimento standard: (dettagli alla fine del catalogo)

- meccanismo Cube - rete a doghe
- materasso a molle Bonnel
- cuscini di seduta composta: parte inferiore in poliuretano alta densità, parte superiore in morbida fibra insacchettata
- cuscini schienale in morbida fibra
- sistema di montaggio a baionetta, sfoderabilità completa, rivestimento in tessuto coordinabile, eco-pelle e pelle

### Standard equipment: (details at the end of catalogue)

- mechanism Cube - orthopaedic bedstead with slats
- spring Bonnel mattress
- composed seat cushions: underlying part in high density polyurethane, upper part in soft pocketed fibre
- backrest cushions in soft fibre
- bayonet mount system, completely removable covers, in coordinabile fabric, similar leather and leather

### Opzioni: (dettagli alla fine del catalogo)

- materassi: molle insacchettate indipendenti, molle insacchettate con lastra in memory, poliuretano ad elevato confort, poliuretano con lastra in memory, poliuretano indeformabile h.18 ad elevato confort
- coprimaterasso bianco con elastico, lavabile
- cuscini d'arredamento e pouf in tessuto coordinabile
- divani e poltrone anche senza letto

### Options: (details at the end of catalogue)

- mattress: independent pocket spring mattress, independent pocket spring mattress with memory, polyurethane foam mattress - high confort, memory foam mattress, polyurethane foam mattress h.18 - high confort
- mattress cover white fabric, washable with elastic
- cushions and pouf in coordinabile fabric
- sofas and armchairs even without bed

### BK 131

Materasso  
Mattress

Boss

Misura  
Size

cm 176 x 195  
cm 156 x 195  
cm 142 x 195  
cm 116 x 195  
cm 102 x 195  
cm 77 x 195  
cm 67 x 195

Misura divano  
Sofa size

209  
189  
175  
149  
135  
109  
99

Poltrona fissa  
Fixed armchair

76

**BK** ITALIA

*Convertibles*

**Trasformabile  
BK 131**



**BK** ITALIA

*Convertibles*

**Trasformabile  
BK 131**





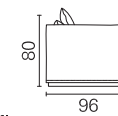
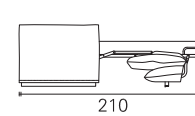
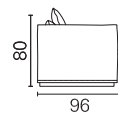
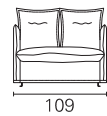
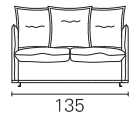
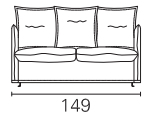
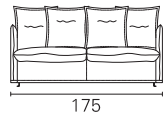
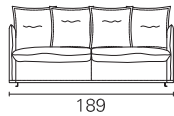
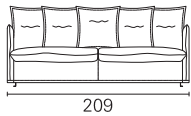

poltrona fissa  
fixed armchair

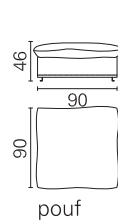

pouf

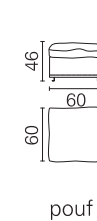

pouf

## BK 132

### Allestimento standard: (dettagli alla fine del catalogo)

- meccanismo Cube - rete a doghe
- materasso a molle Bonnel
- cuscini di seduta composta: parte inferiore in poliuretano alta densità, parte superiore in morbida fibra insacchettata
- cuscini d'arredamento 60x60 in morbida fibra
- schienale con imbottitura in poliuretano completa, per un maggiore confort
- sistema di montaggio a baionetta, sfoderabilità completa, rivestimento in tessuto coordinabile, eco-pelle e pelle

### Standard equipment: (details at the end of catalogue)

- mechanism Cube - orthopaedic bedstead with slats
- spring Bonnel mattress
- composed seat cushions: underlying part in high density polyurethane, upper part in soft pocketed fibre
- 60x60 cushions in soft fibre
- backrest with full polyurethane padding, for added comfort
- bayonet mount system, completely removable covers, in coordinabile fabric, similar leather and leather

### Opzioni: (dettagli alla fine del catalogo)

- materassi: molle insacchettate indipendenti, molle insacchettate con lastra in memory, poliuretano ad elevato confort, poliuretano con lastra in memory, poliuretano indeformabile h.18 ad elevato confort
- coprimaterasso bianco con elastico, lavabile
- pouf in tessuto coordinabile
- divani e poltrone anche senza letto

### Options: (details at the end of catalogue)

- mattress: independent pocket spring mattress, independent pocket spring mattress with memory, polyurethane foam mattress - high confort, memory foam mattress, polyurethane foam mattress h.18 - high confort
- mattress cover white fabric, washable with elastic
- pouf in coordinabile fabric
- sofas and armchairs even without bed

### BK 132

Materasso  
Mattress

Boss

Misura  
Size

cm 176 x 195  
cm 156 x 195  
cm 142 x 195  
cm 116 x 195  
cm 102 x 195  
cm 77 x 195  
cm 67 x 195

Misura divano  
Sofa size

209  
189  
175  
149  
135  
109  
99

Poltrona fissa  
Fixed armchair

76

**BK** ITALIA

*Convertibles*

**Trasformabile  
BK 132**



**BK** ITALIA

*Convertibles*

**Trasformabile  
BK 132**







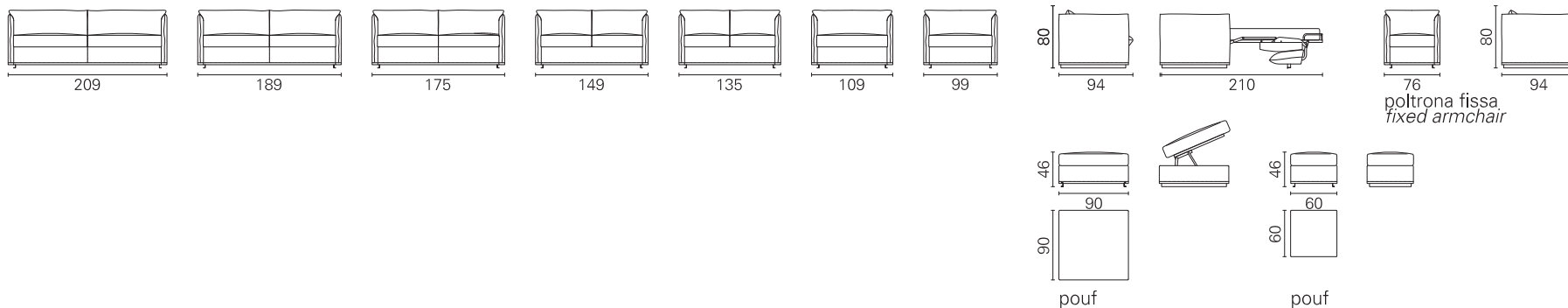

## BK 133

### Allestimento standard: (dettagli alla fine del catalogo)

- meccanismo Cube - rete a doghe
- materasso a molle Bonnel
- cuscini di seduta con densità differenziata per un maggiore confort (in opzione anche in memory foam)
- cuscini di schienale con imbottitura in poliuretano completa, per un maggiore confort
- sistema di montaggio a baionetta, sfoderabilità completa, rivestimento in tessuto coordinabile, eco-pelle e pelle

### Standard equipment: (details at the end of catalogue)

- mechanism Cube - orthopaedic bedstead with slats
- spring Bonnel mattress
- dual-density seat cushions for added comfort (optionally also in memory foam)
- backrest cushions with full polyurethane padding, for added comfort
- bayonet mount system, completely removable covers, in coordinabile fabric, similar leather and leather

### Opzioni: (dettagli alla fine del catalogo)

- materassi: molle insacchettate indipendenti, molle insacchettate con lastra in memory, poliuretano ad elevato confort, poliuretano con lastra in memory, poliuretano indeformabile h.18 ad elevato confort
- coprimaterasso bianco con elastico, lavabile
- cuscini d'arredamento e pouf in tessuto coordinabile
- divani e poltrone anche senza letto

### Options: (details at the end of catalogue)

- mattress: independent pocket spring mattress, independent pocket spring mattress with memory, polyurethane foam mattress - high confort, memory foam mattress, polyurethane foam mattress h.18 - high confort
- mattress cover white fabric, washable with elastic
- cushions and pouf in coordinabile fabric
- sofas and armchairs even without bed

### BK 133

Materasso  
Mattress

Boss

Misura  
Size

cm 176 x 195  
cm 156 x 195  
cm 142 x 195  
cm 116 x 195  
cm 102 x 195  
cm 77 x 195  
cm 67 x 195

Misura divano  
Sofa size

209  
189  
175  
149  
135  
109  
99  
76

Poltrona fissa  
Fixed armchair

**BK** ITALIA

*Convertibles*

**Trasformabile**  
**BK 133**





**BK** ITALIA

*Convertibles*

**Materassi**  
***Mattresses***



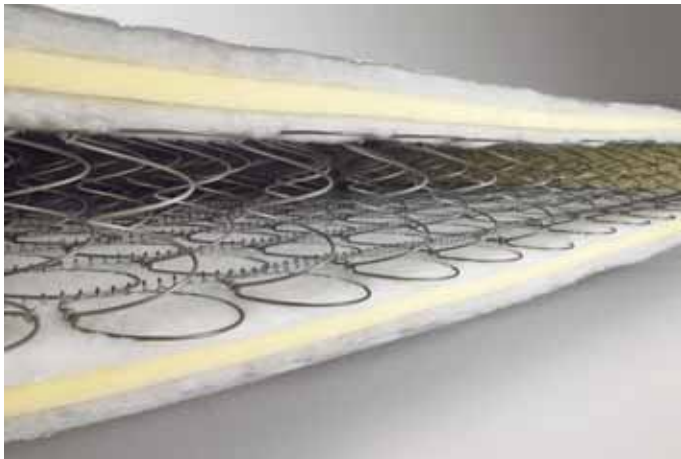

**Il materasso a molle Bonnell** è la tipologia più diffusa al mondo

**Caratteristiche e utilizzo:** Materasso robusto, durevole, rigido, traspirante, consigliato a chi lascia il divano chiuso per lunghi periodi. La struttura tradizionale delle molle legate tra loro da una spirale in acciaio permette la piegatura del materasso senza che sia danneggiato. La struttura a carcassa risulta per sua natura anallergica, atossica, antimicrobica e igienica oltre a conferire al materasso massima traspirabilità e indeformabilità.

**Materiali:** Il materasso è composto da una carcassa di filo d'acciaio fosfatato e temprato Ø 2.2 mm, rivestita con feltri senza fenoli, ovatte in fibra, lastre in poliuretano espanso a densità differenziate e tessuto di rivestimento in filo di poliestere e fibra modacrilica. Tutti i materiali sono ignifughi e i materassi sono omologati in classe di reazione al fuoco 1IM secondo le rigide procedure del Ministero degli Interni italiano.

**The spring Bonnell mattress** is the most common in the world

**Features and use:** strong, durable, rigid and breathable mattress, recommended for those who leave the sofa closed for long periods. The traditional structure of the springs linked together by a steel spiral allows the folding of the mattress without damage. This structure is by his nature hypoallergenic, non-toxic, antimicrobial and healthy and moreover gives breathability and rigidity to the mattresses.

**Materials:** Spring Bonnell mattress is made of a phosphatized and tempered steel wire frame Ø 2.2 mm, covered with free phenol felts, wadding fiber, foam with different density and covering fabric in polyester and modacrylic fiber. All materials are fire retardant and moreover mattresses are 1 IM fire reaction class in accordance with the strict laws of Italian rules.

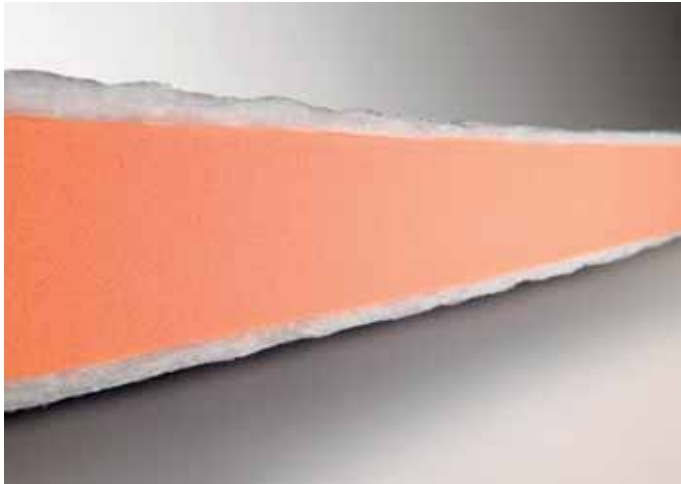

**Il materasso in poliuretano indeformabile ad elevato confort** è un ottimo compromesso che combina adattabilità e sostegno.

**Caratteristiche e utilizzo:** Materasso elastico, con buona adattabilità, consigliato per l'uso quotidiano, per i climi freddi e per chi non ha difficoltà nella regolazione termica (il poliuretano è un ottimo isolante termico). La struttura è costituita da una lastra in poliuretano ad alta densità che garantisce ottimo sostegno ma è al tempo stesso morbido e accogliente.

**Materiali:** Il materasso è composto da un'anima di poliuretano espanso ignifugo senza C.F.C. di **densità 40 kg/mc** indeformabile, rivestito da una falda di fibra termolegata. Il tessuto di rivestimento è in filo di poliestere e fibra modacrilica. Tutti i materiali sono ignifughi e i materassi sono omologati in classe di reazione al fuoco 1IM secondo le rigide procedure del Ministero degli Interni italiano.

**The polyurethane foam mattress - high confort** is a good compromise that combines adaptability and support.

**Features and use:** elastic mattress, with good adaptability, recommended for everyday use, for cold climates and for those who have not difficulty in thermal regulation (polyurethane is an excellent thermal insulator).

The structure is made from a layer of high density polyurethane that ensures good support but at the same time soft and comfortable.

**Materials:** Polyurethane mattress is made by a polyurethane foam core with no C.F.C., with a **density of 40 kg/mc** non-deformable, covered with a heat sealed layer. The covering fabric is in polyester and modacrylic fiber. All materials are fire retardant and moreover mattresses are 1 IM fire reaction class in accordance with the strict laws of Italian rules.

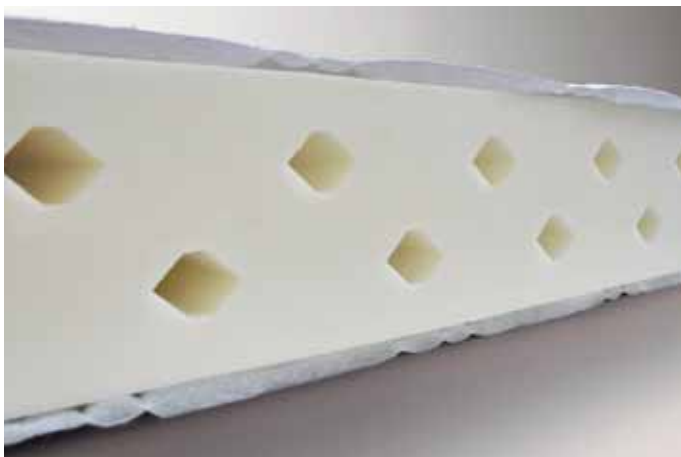

**Il materasso in poliuretano indeformabile h.18 ad elevato confort** è un ottimo compromesso che combina adattabilità, sostegno e traspirabilità.

**Caratteristiche e utilizzo:** Materasso alto 18 centimetri molto elastico, con ottima adattabilità, consigliato sia per l'uso quotidiano che saltuario, per climi freddi e caldi. La struttura è costituita da una lastra in poliuretano ad alta densità che garantisce ottimo sostegno, ma è al tempo stesso morbido e accogliente che, grazie alla presenza di ampie camere d'aria orizzontali, garantisce una ottima traspirabilità.

**Materiali:** Il materasso è composto da un'anima di poliuretano espanso ignifugo senza C.F.C. di **densità 35 kg/mc** indeformabile, ad alto indice di elasticità, rivestito da una falda di fibra termolegata. Il tessuto di rivestimento è in filo di poliestere e fibra modacrilica..

**The polyurethane foam mattress h.18 - high confort** is a great compromise that combines adaptability, support and breathability.

**Features and use:** very elastic 18 cm high mattress, with a great adaptability, recommended for both daily and occasional use, for cold and hot climates. The structure is made from a layer of high density polyurethane that ensures a great support but at the same time soft and comfortable and, thanks to the presence of large horizontal air chambers, guarantees excellent breathability.

**Materials:** Polyurethane mattress is made by a polyurethane foam core with no C.F.C., with a **density of 35 kg/mc** non-deformable, with high elasticity index, covered with a heat sealed layer. The covering fabric is in polyester and modacrylic fiber.

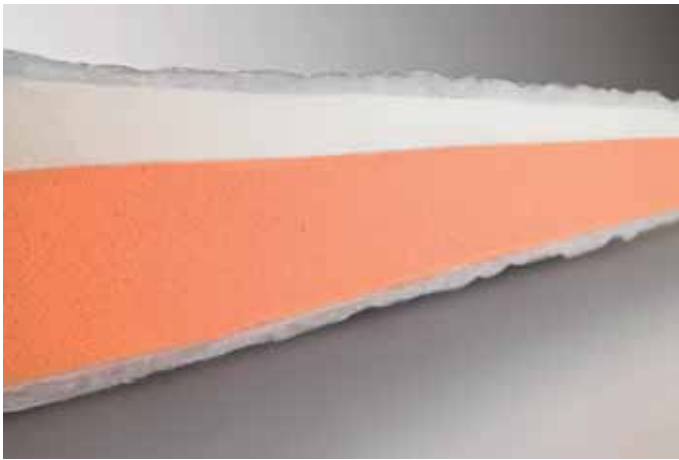

**Il materasso in memory** sfrutta al meglio le caratteristiche ergonomiche del poliuretano visco-elastico

**Caratteristiche e utilizzo:** Materasso ergonomico ad ottime prestazioni di confort, consigliato per l'uso quotidiano. La struttura è costituita da due lastre in poliuretano: una ad alta densità che garantisce sostegno, e una, nella parte superiore, in schiuma visco-elastica che conferisce al materasso l'effetto "memoria", poiché sollecitato dal peso del corpo si automodella ritornando poi alla forma originaria.

**Materiali:** Il materasso è composto da un'anima di poliuretano espanso ignifugo senza C.F.C. di **densità 40 kg/mc** indeformabile combinata con una lastra in schiuma visco-elastica nella parte superiore. Tutti i materiali sono ignifughi e i materassi sono omologati in classe di reazione al fuoco 1IM secondo le rigide procedure del Ministero degli Interni italiano.

**Memory foam mattress** takes full advantage of the ergonomic features of the visco-elastic

**Features and use:** Ergonomic mattress with impressive performance of comfort, recommended for everyday use. The structure consists of two layers of polyurethane: one in a high density which ensures support, and, in the upper part, the visco-elastic foam that gives the "memory effect": higher-density memory foam softens in reaction to body heat, allowing it to mold to a warm body in a few minutes.

**Materials:** Memory foam mattress is made by a polyurethane foam core with no C.F.C., with a **density of 40 kg/mc** non-deformable, combined with a polyurethane viscoelastic foam layer, and covered with a heat sealed layer. The covering fabric is in polyester and modacrylic fiber. All materials are fire retardant and moreover mattresses are 1 IM fire reaction class in accordance with the strict laws of Italian rules.



**Il materasso a molle insacchettate indipendenti** è la tecnologia a molle di ultima generazione

**Caratteristiche e utilizzo:** Materasso elastico, ergonomico, traspirante, consigliato per l'uso quotidiano e per persone non troppo robuste. La struttura, costituita da molle indipendenti, rivestite singolarmente e successivamente assemblate, rende il materasso flessibile, morbido e adattabile ad ogni tipo di sollecitazione. Le molle sono di diametro inferiore alle Bonnel e quindi in numero superiore.

**Materiali:** Il materasso è composto da una carcassa di molle in acciaio insacchettate e indipendenti rivestita con feltri senza fenoli, ovatte in fibra, lastre in poliuretano espanso a densità differenziate e tessuto di rivestimento in filo di poliestere e fibra modacrilica. Tutti i materiali sono ignifughi e i materassi sono omologati in classe di reazione al fuoco 1IM secondo le rigide procedure del Ministero degli Interni italiano.

**The independent pocket spring mattress** is the latest generation of spring mattresses technology

**Features and use:** elastic, ergonomic and breathable mattress, recommended for everyday use and for people not too heavy. The structure, made up of independent pocket springs, coated individually and then assembled, makes the mattress flexible, soft and adaptable to any type of stress. These springs are smaller than Bonnel, and then in higher number.

**Materials:** The mattress is made by a structure of independent pocket steel springs covered covered with free phenol felts, wadding fiber, foam with different density and covering fabric in polyester and modacrylic fiber. All materials are fire retardant and moreover mattresses are 1 IM fire reaction class in accordance with the strict laws of Italian rules.



**Il materasso a molle insacchettate con lastra in memory** combina ed esalta due soluzioni di alta tecnologia

**Caratteristiche e utilizzo:** Materasso ergonomico ad elevate prestazioni di confort, consigliato per l'uso quotidiano e clienti particolarmente esigenti nella qualità del dormire ma non troppo robusti. La struttura, costituita da molle indipendenti, rende il materasso flessibile, morbido e adattabile ad ogni tipo di sollecitazione. La lastra in schiuma visco-elastica nella parte superiore esalta le caratteristiche della struttura e aggiunge l'effetto "memoria" al materasso che, sollecitato dal peso del corpo, si automodella ritornando poi alla forma originaria.

**Materiali:** Il materasso è composto da una carcassa di molle in acciaio insacchettate e indipendenti rivestita con feltri senza fenoli, ovatte in fibra, lastre in poliuretano espanso a densità differenziate, nella parte superiore, lastra in schiuma visco-elastica. Il tessuto di rivestimento è in filo di poliestere e fibra modacrilica.

**The independent pocket spring mattress with memory foam** combines and enhances two high-tech solutions

**Features and use:** ergonomic mattress with high-performance comfort, recommended for everyday use and for particularly demanding customers about the quality of sleep, but not for too heavy people.

The structure, made up of independent pocket springs, makes the mattress flexible, soft and adaptable to any type of stress. The viscoelastic layer gives to the mattress a "memory effect": the higher-density memory foam softens in reaction to body heat, allowing it to mold to a warm body in a few minutes.

**Materials:** The mattress is made by a structure of independent pocket steel springs covered with free phenol felts, wadding fiber, foam with different density and covering fabric in polyester and modacrylic fiber. In the upper part there is a polyurethane viscoelastic foam layer.

**Topper:**

per aumentare il confort durante il sonno.

Composto da morbida fibra da gr 400/m<sup>2</sup>, con rivestimento in tessuto 100% cotone ecrù, lavabile. Dotato di quattro elastici negli angoli, per un saldo fissaggio al materasso.

Attenzione: il Topper deve essere rimosso prima di chiudere il divano letto.

**Topper:**

*to increase comfort during sleep.*

*Made of soft 400 g/m<sup>2</sup> fiber, covered in 100% ecru cotton fabric, washable. Equipped with four elastic bands in the corners, for a firm attachment to the mattress.*

*Attention: the Topper must be removed before closing the sofa bed.*

**Borsa per Topper:**

per riporlo comodamente dopo averlo rimosso dal materasso. Composta da un tessuto con marchio BK ITALIA in cotone 100% e con una cerniera perimetrale su tre lati, per facilitare l'inserimento del Topper.

**Topper bag:**

*for convenient storage, after removing it from the mattress.*

*Made of 100% cotton fabric with the BK ITALIA brand and with a perimeter zip on three sides, to facilitate the insertion of the Topper.*

**Coprimaterasso:**

per rivestire e proteggere il materasso.

Composto da un tessuto in 100% poliestere anallergico e lavabile e con elastico perimetrale per facilitare il fissaggio al materasso.

**Mattress cover:**

*to cover and protect the mattress.*

*Made of 100% hypoallergenic and washable polyester fabric and with elastic around the edges to facilitate attachment to the mattress.*



**Cube****Sistema rete ortopedica tradizionale con doghe da cm 7**

In questo sistema sono presenti 2 liste di doghe di multistrato di faggio evaporato senza formaldeide, larghe cm. 7, il cui spessore varia da mm. 12 a mm. 8, a seconda della lunghezza. La curvatura verso l'alto permette una perfetta ergonomia.

**Traditional orthopaedic bed base with 7 cm strip slats**

*In this System, we have two series of beechwood multi-ply slats vapour treated without formaldehyde. They are 7 cm wide and their thickness ranges from 12 mm to 8 mm, depending on the length. The upward bending allows a perfect ergonomics.*

**Dettaglio meccanismi e doga / Mechanism details and slats**

Rete ortopedica tradizionale formata da uno speciale profilo in tubo quadro cavato e raccordato ai vertici con scatole in lamiera sagomate BK. Le reti matrimoniali da 140/160/180 cm con traverso centrale in appoggio. Doghe curvate in multistrato di faggio evaporato da 7 cm, spessore da 8 a 12 mm, sezione ondulata con nervatura longitudinale tipo Welle, doga con maggior resistenza elastica e miglior respirabilità del materasso in appoggio.

*Traditional orthopaedic bed base formed by a steel square-tubed profile with special BK connection plates in the corners. 140/160/180 cm double frames are equipped with central support. Multilayered convex slats in beech wood are 7 cm wide and thickness from 8 to 12 mm, waved section with longitudinal ribs called Welle. This singular shape gives to the slats more elastic strength and better breathability to the mattress.*





**BK** ITALIA

*Convertibles*

BK Group srl  
Via Bergamo 66,  
24047 Treviglio (BG) Italy  
T+39 0363 48971  
F+39 0363 45917

[info@bkitalia.com](mailto:info@bkitalia.com)  
[www.bkitalia.com](http://www.bkitalia.com)